

Climax[®]

Pneumatics



ISO 6431 Tie Rod Cylinders

1-800-732-8704
Easley, South Carolina

Climax® ISO 6431 Tie Rod Cylinders



End Caps

*ø32-160mm Pressure Diecast Aluminum
ø200-320mm Gravity Cast Aluminum*

Tube

Anodized Aluminum

Tie Rods

High Strength Steel

Piston Seals

*ø32-100mm Polyurethane
ø125-320mm Nitrile Rubber*

Piston Rod

Chromium Coated Stainless Steel

Working Pressure	<i>ø32-200mm 1 to 16 bar ø250 & 320mm 1 to 10 bar</i>
Temperature	<i>-20°C to 80°C max</i>
Working Fluid	<i>Filtered compressed air, lubricated or not</i>

Available Versions

<i>Double Acting, Magnetic, Cushioned</i>
<i>Double Acting, Magnetic, Cushioned, Through Piston Rod</i>

Standard Strokes

ø mm	25	40	50	80	100	125	160	200	250	300	320	400	500
32	•	•	•	•	•	•	•	•	•	•	•	•	•
40	•	•	•	•	•	•	•	•	•	•	•	•	•
50	•	•	•	•	•	•	•	•	•	•	•	•	•
63	•	•	•	•	•	•	•	•	•	•	•	•	•
80	•	•	•	•	•	•	•	•	•	•	•	•	•
100	•	•	•	•	•	•	•	•	•	•	•	•	•
125	•	•	•	•	•	•	•	•	•	•	•	•	•
160	•	•	•	•	•	•	•	•	•	•	•	•	•
200	•	•	•	•	•	•	•	•	•	•	•	•	•
250	•	•	•	•	•	•	•	•	•	•	•	•	•
320	•	•	•	•	•	•	•	•	•	•	•	•	•

Non-Standard Strokes are readily available

Climax® ISO 6431 Tie Rod Cylinders

How to Order Base Models

CX 032 A 0 2 M 100 B A C TM400 1 2

Series

CX – ISO 6431 Tie Rod Cylinder

Bore

- 032 – 32 mm 125 – 125 mm
- 040 – 40 mm 160 – 160 mm
- 050 – 50 mm 200 – 200 mm
- 063 – 63 mm 250 – 250 mm
- 080 – 80 mm 320 – 320 mm
- 100 – 100 mm

Cushioning

A – Adjustable Cushioning Standard

Range

- 0 – Single Rod
- 2 – Through Rod

Magnet

2 – Magnetic Piston Standard

Piston Rod Ends

M – Male

Stroke

- 025 – 25 mm 200 – 200 mm
- 040 – 40 mm 250 – 250 mm
- 050 – 50 mm 300 – 300 mm
- 080 – 80 mm 320 – 320 mm
- 100 – 100 mm 400 – 400 mm
- 125 – 125 mm 500 – 500 mm
- 160 – 160 mm

Piston Rod Material

B – Chromium Coated Stainless Steel

Tie Rod Material

A – High Strength Steel

Body Material

C – Anodized Aluminum

Side Trunnion

Blank – No Trunnion

TM*** – *** = "XV" Dimension (please specify)

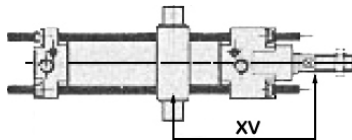

Port Position - Head

- 1 – Position 1
- 2 – Position 2
- 3 – Position 3
- 4 – Position 4

Port Position - Cap

- 1 – Position 1
- 2 – Position 2
- 3 – Position 3
- 4 – Position 4

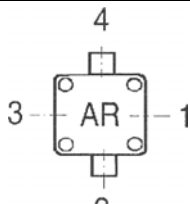

Climax® ISO 6431 Tie Rod Cylinders

Double Acting Single Rod

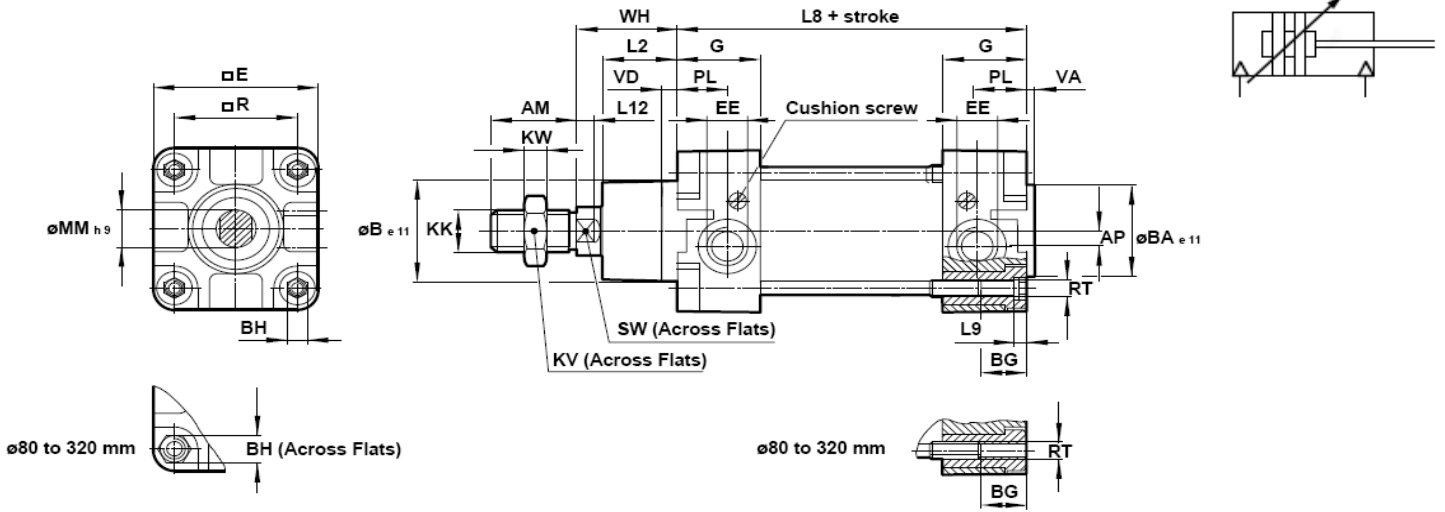

Double Acting Through Rod

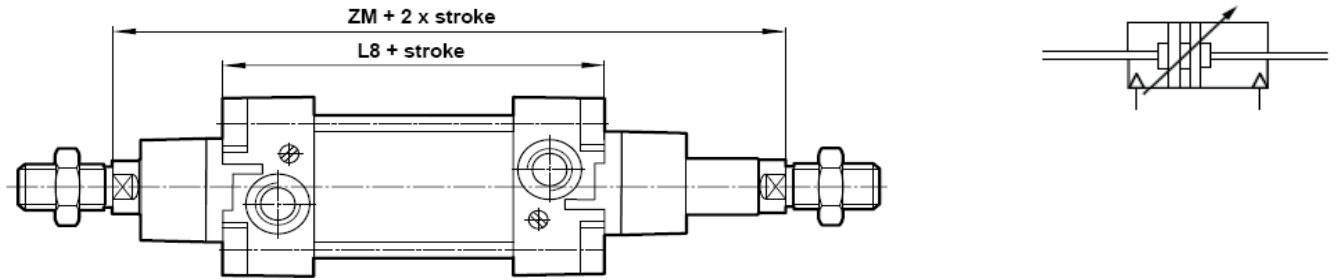

ømm	AM	AP	øBe11	øBAe11	BG	BH	øE	EE	G	KK	KV	KW
32	0.87 (22)	0.14 (3.5)	1.18 (30)	1.18 (30)	0.71 (18)	0.24 (6)	1.85 (47)	G 1/8 (1/8" NPT)	1.08 (27.5)	M10x1.25	0.67 (17)	0.20 (5)
40	0.94 (24)	0.18 (4.5)	1.38 (35)	1.38 (35)	0.71 (18)	0.24 (6)	2.09 (53)	G 1/4 (1/4" NPT)	1.26 (32)	M12x1.25	0.75 (19)	0.24 (6)
50	1.26 (32)	0.24 (6)	1.57 (40)	1.57 (40)	0.71 (18)	0.31 (8)	2.56 (65)	G 1/4 (1/4" NPT)	1.22 (31)	M16x1.5	0.94 (24)	0.31 (8)
63	1.26 (32)	0.39 (10)	1.77 (45)	1.77 (45)	0.69 (17.5)	0.31 (8)	2.95 (75)	G 3/8 (3/8" NPT)	1.30 (33)	M16x1.5	0.94 (24)	0.31 (8)
80	1.57 (40)	0.33 (8.5)	1.77 (45)	1.77 (45)	0.85 (21.5)	0.75 (19)	3.74 (95)	G 3/8 (3/8" NPT)	1.30 (33)	M20x1.5	1.18 (30)	0.39 (10)
100	1.57 (40)	0.35 (9)	2.17 (55)	2.17 (55)	0.85 (21.5)	0.75 (19)	4.53 (115)	G 1/2 (1/2" NPT)	1.46 (37)	M20x1.5	1.18 (30)	0.39 (10)
125	2.13 (54)	0.39 (10)	2.36 (60)	2.36 (60)	1.26 (32)	0.94 (24)	5.51 (140)	G 1/2 (1/2" NPT)	1.81 (46)	M27x2	1.61 (41)	0.53 (13.5)
160	2.83 (72)	0.71 (18)	2.56 (65)	2.56 (65)	1.12 (28.5)	1.26 (32)	7.22 (183.5)	G 3/4 (3/4" NPT)	1.97 (50)	M36x2	2.17 (55)	0.71 (18)
200	2.83 (72)	0.71 (18)	2.95 (75)	2.95 (75)	1.12 (28.5)	1.26 (32)	8.82 (224)	G 3/4 (3/4" NPT)	1.97 (50)	M36x2	2.17 (55)	0.71 (18)
250	3.31 (84)	0.89 (22.5)	3.54 (90)	3.54 (90)	1.38 (35)	1.42 (36)	11.02 (280)	G 1 (1" NPT)	2.28 (58)	M42x2	2.56 (65)	0.83 (21)
320	3.78 (96)	0.89 (22.5)	4.33 (110)	4.33 (110)	1.18 (30)	1.81 (46)	13.78 (350)	G 1 (1" NPT)	2.36 (60)	M48x2	2.95 (75)	0.94 (24)

ømm	L2	L8	L9	L12	øMMh9	PL	øR	RT	SW	VA	VD	WH	ZM
32	0.79 (20)	3.70 (94)	0.16 (4)	0.24 (6)	0.47 (12)	0.51 (13)	1.26 (32.5)	M 6	0.39 (10)	0.12 (3)	0.24 (6)	1.02 (26)	5.75 (146)
40	0.87 (22)	4.13 (105)	0.16 (4)	0.26 (6.5)	0.63 (16)	0.59 (15)	1.50 (38)	M 6	0.51 (13)	0.14 (3.5)	0.24 (6)	1.18 (30)	6.50 (165)
50	1.06 (27)	4.17 (106)	0.20 (5)	0.31 (8)	0.79 (20)	0.73 (18.5)	1.83 (46.5)	M 8	0.67 (17)	0.14 (3.5)	0.24 (6)	1.46 (37)	7.09 (180)
63	1.14 (29)	4.76 (121)	0.20 (5)	0.31 (8)	0.79 (20)	0.75 (19)	2.22 (56.5)	M 8	0.67 (17)	0.16 (4)	0.24 (6)	1.46 (37)	7.68 (195)
80	1.30 (33)	5.04 (128)	-	0.39 (10)	0.98 (25)	0.75 (19)	2.83 (72)	M 10	0.87 (22)	0.16 (4)	0.24 (6)	1.81 (46)	8.66 (220)
100	1.42 (36)	5.43 (138)	-	0.39 (10)	0.98 (25)	0.71 (18)	3.50 (89)	M 10	0.87 (22)	0.16 (4)	0.24 (6)	2.01 (51)	9.45 (240)
125	1.77 (45)	6.30 (160)	-	0.51 (13)	1.26 (32)	0.79 (20)	4.33 (110)	M 12	1.06 (27)	0.24 (6)	0.61 (15.5)	2.56 (65)	11.42 (290)
160	2.28 (58)	7.09 (180)	-	0.63 (16)	1.57 (40)	0.83 (21)	5.51 (140)	M 16	1.42 (36)	0.16 (4)	0.59 (15)	3.15 (80)	13.39 (340)
200	2.64 (67)	7.09 (180)	-	0.63 (16)	1.57 (40)	0.83 (21)	6.89 (175)	M 16	1.42 (36)	0.20 (5)	0.59 (15)	3.74 (95)	14.57 (370)
250	3.15 (80)	7.87 (200)	-	0.79 (20)	1.97 (50)	1.14 (29)	8.66 (220)	M 20	1.61 (41)	0.28 (7)	0.51 (13)	4.13 (105)	-

Climax® ISO 6431 Tie Rod Cylinders

Mounting Accessories for Tie Rod Cylinders

Front or Rear Stud

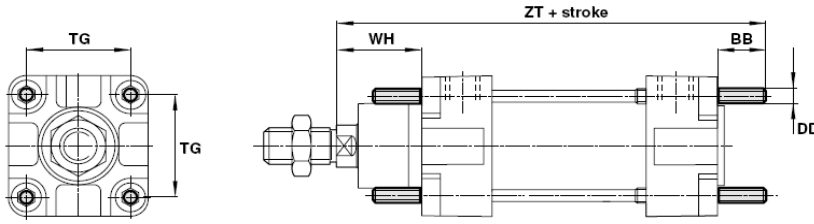

∅ mm	Part Number
32	MX1-032
40	MX1-040
50	MX1-050
63	MX1-063
80	MX1-080
100	MX1-100
125	MX1-125
160	MX1-160
200	MX1-200
250	MX1-250
320	MX1-320

Front or Rear Flange

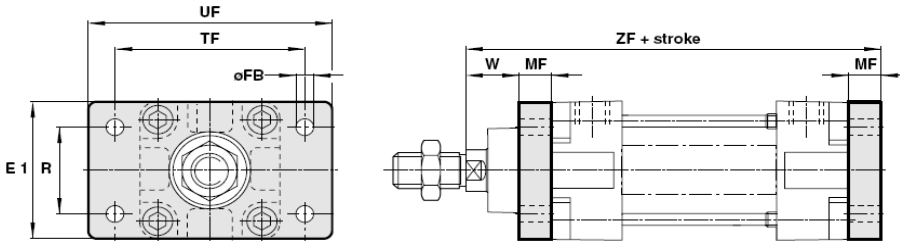

∅ mm	Part Number
32	MF-032
40	MF-040
50	MF-050
63	MF-063
80	MF-080
100	MF-100
125	MF-125
160	MF-160
200	MF-200
250	MF-250
320	MF-320

Foot Mount

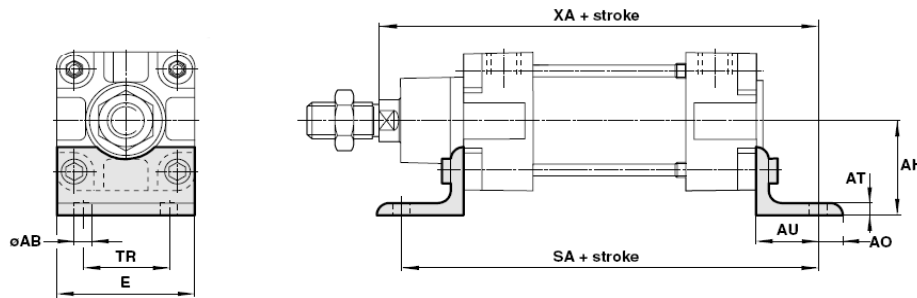

∅ mm	Part Number
32	MS1-032
40	MS1-040
50	MS1-050
63	MS1-063
80	MS1-080
100	MS1-100
125	MS1-125
160	MS1-160
200	MS1-200
250	MS1-250
320	MS1-320

∅mm	∅AB	AH	AO	AT	AU	BB	DD	E	E1	∅FB	MF
32	0.28 (7)	1.26 (32)	0.31 (8)	0.16 (4)	0.94 (24)	0.67 (17)	M 6	1.89 (48)	1.97 (50)	0.28 (7)	0.39 (10)
40	0.35 (9)	1.42 (36)	0.35 (9)	0.16 (4)	1.10 (28)	0.67 (17)	M 6	2.09 (53)	2.17 (55)	0.35 (9)	0.39 (10)
50	0.35 (9)	1.77 (45)	0.39 (10)	0.20 (5)	1.26 (32)	0.91 (23)	M 8	2.52 (64)	2.56 (65)	0.35 (9)	0.47 (12)
63	0.35 (9)	1.97 (50)	0.47 (12)	0.20 (5)	1.26 (32)	0.91 (23)	M 8	2.91 (74)	2.95 (75)	0.35 (9)	0.47 (12)
80	0.47 (12)	2.48 (63)	0.75 (19)	0.20 (5)	1.61 (41)	1.10 (28)	M 10	3.86 (98)	3.94 (100)	0.47 (12)	0.63 (16)
100	0.55 (14)	2.80 (71)	0.75 (19)	0.20 (5)	1.61 (41)	1.10 (28)	M 10	4.53 (115)	4.72 (120)	0.55 (14)	0.63 (16)
125	0.63 (16)	3.54 (90)	0.79 (20)	0.35 (9)	1.77 (45)	1.34 (34)	M 12	5.51 (140)	5.51 (140)	0.63 (16)	0.79 (20)
160	0.71 (18)	4.53 (115)	0.79 (20)	0.31 (8)	2.36 (60)	1.65 (42)	M 16	7.09 (180)	7.09 (180)	0.71 (18)	0.79 (20)
200	0.87 (22)	5.31 (135)	1.18 (30)	0.35 (9)	2.76 (70)	1.65 (42)	M 16	8.66 (220)	8.66 (220)	0.87 (22)	0.98 (25)
250	1.02 (26)	6.50 (165)	1.38 (35)	0.39 (10)	2.95 (75)	1.97 (50)	M 20	11.02 (280)	11.02 (280)	1.02 (26)	0.98 (25)
320	1.30 (33)	7.87 (200)	1.77 (45)	0.63 (16)	3.35 (85)	2.36 (60)	M 24	13.78 (350)	13.78 (350)	1.30 (33)	1.18 (30)

∅mm	R	SA	TF	□TG	TR	UF	W	WH	XA	ZF	ZT
32	1.26 (32)	5.59 (142)	2.52 (64)	1.28 (32.5)	1.26 (32)	3.15 (80)	0.63 (16)	1.02 (26)	5.67 (144)	5.12 (130)	5.39 (137)
40	1.42 (36)	6.34 (161)	2.83 (72)	1.50 (38)	1.42 (36)	3.54 (90)	0.79 (20)	1.18 (30)	6.42 (163)	5.71 (145)	5.98 (152)
50	1.77 (45)	6.69 (170)	3.54 (90)	1.83 (46.5)	1.77 (45)	4.33 (110)	0.98 (25)	1.46 (37)	6.89 (175)	6.10 (155)	6.54 (166)
63	1.97 (50)	7.28 (185)	3.94 (100)	2.22 (56.5)	1.97 (50)	4.92 (125)	0.98 (25)	1.46 (37)	7.48 (190)	6.69 (170)	7.13 (181)
80	2.48 (63)	8.27 (210)	4.96 (126)	2.83 (72)	2.48 (63)	6.06 (154)	1.18 (30)	1.81 (46)	8.46 (215)	7.48 (190)	7.95 (202)
100	2.95 (75)	8.66 (220)	5.91 (150)	3.50 (89)	2.95 (75)	7.32 (186)	1.38 (35)	2.01 (51)	9.06 (230)	8.07 (205)	8.54 (217)
125	3.54 (90)	9.84 (250)	7.09 (180)	4.33 (110)	3.54 (90)	8.82 (224)	1.77 (45)	2.56 (65)	10.63 (270)	9.65 (245)	10.20 (259)
160	4.53 (115)	11.81 (300)	9.06 (230)	5.51 (140)	4.53 (115)	11.02 (280)	2.36 (60)	3.15 (80)	12.60 (320)	11.02 (280)	11.89 (302)
200	5.31 (135)	12.60 (320)	10.63 (270)	6.89 (175)	5.31 (135)	12.60 (320)	2.76 (70)	3.74 (95)	13.58 (345)	11.81 (300)	12.48 (317)
250	6.50 (165)	13.78 (350)	12.99 (330)	8.66 (220)	6.50 (165)	15.55 (395)	3.15 (80)	4.13 (105)	14.96 (380)	12.99 (330)	13.98 (355)

Climax® ISO 6431 Tie Rod Cylinders

Mounting Accessories for Tie Rod Cylinders

Piston Rod Clevis

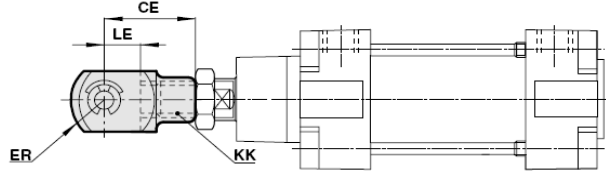
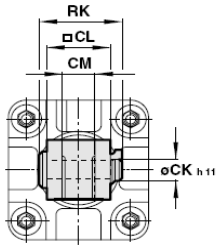

ø mm	Part Number
32	FEC10x125
40	FEC12x125
50	FEC16x150
63	FEC16x150
80	FEC20x150
100	FEC20x150
125	FEC27x200
160	FEC36x200
200	FEC36x200
250	FEC42x200
320	FEC42x200

Front Hinge Bracket

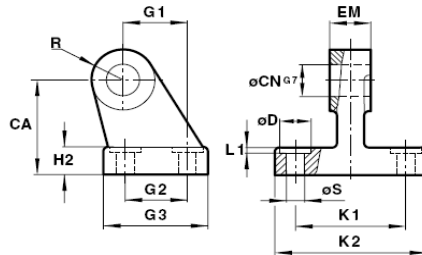

ø mm	Part Number
32	MFH-032
40	MFH-040
50	MFH-050
63	MFH-063
80	MFH-080
100	MFH-100
125	MFH-125
160	MFH-160
200	MFH-200
250	MFH-250
320	MFH-320

ømm	CA	CE	øCKh11	CL	CM	øCNG7	øD	EM	ER	G1	G2
32	1.26 (32)	1.57 (40)	0.39 (10)	0.79 (20)	0.39 (10)	0.39 (10)	0.43 (11)	0.39 (10)	0.63 (16)	0.83 (21)	0.71 (18)
40	1.42 (36)	1.89 (48)	0.47 (12)	0.94 (24)	0.47 (12)	0.47 (12)	0.43 (11)	0.47 (12)	0.75 (19)	0.94 (24)	0.87 (22)
50	1.77 (45)	2.52 (64)	0.63 (16)	1.26 (32)	0.63 (16)	0.63 (16)	0.59 (15)	0.63 (16)	0.98 (25)	1.30 (33)	1.18 (30)
63	1.97 (50)	2.52 (64)	0.63 (16)	1.26 (32)	0.63 (16)	0.63 (16)	0.59 (15)	0.63 (16)	0.98 (25)	1.46 (37)	1.38 (35)
80	2.48 (63)	3.15 (80)	0.79 (20)	1.57 (40)	0.79 (20)	0.79 (20)	0.71 (18)	0.79 (20)	1.26 (32)	1.85 (47)	1.57 (40)
100	2.80 (71)	3.15 (80)	0.79 (20)	1.57 (40)	0.79 (20)	0.79 (20)	0.71 (18)	0.79 (20)	1.26 (32)	2.17 (55)	1.97 (50)
125	3.54 (90)	4.33 (110)	1.18 (30)	2.17 (55)	1.18 (30)	1.18 (30)	0.79 (20)	1.18 (30)	1.77 (45)	2.76 (70)	2.36 (60)
160	4.53 (115)	5.67 (144)	1.38 (35)	2.76 (70)	1.38 (35)	1.38 (35)	0.79 (20)	1.38 (35)	2.24 (57)	3.82 (97)	3.46 (88)
200	5.31 (135)	5.67 (144)	1.38 (35)	2.76 (70)	1.38 (35)	1.38 (35)	0.94 (24)	1.38 (35)	2.24 (57)	4.13 (105)	3.54 (90)
250	–	6.61 (168)	1.57 (40)	3.35 (85)	1.57 (40)	–	–	–	2.68 (68)	–	–
320	–	7.56 (192)	1.97 (50)	3.78 (96)	1.97 (50)	–	–	–	3.35 (85)	–	–

ømm	G3	H2	KK	K1	K2	L1	LE	R	RK	øS
32	1.22 (31)	0.31 (8)	M10x1.25	1.50 (38)	2.01 (51)	0.06 (1.6)	0.79 (20)	0.39 (10)	1.10 (28)	0.26 (6.6)
40	1.38 (35)	0.39 (10)	M12x1.25	1.61 (41)	2.13 (54)	0.06 (1.6)	0.94 (24)	0.43 (11)	1.26 (32)	0.26 (6.6)
50	1.77 (45)	0.47 (12)	M16x1.5	1.97 (50)	2.56 (65)	0.06 (1.6)	1.26 (32)	0.51 (13)	1.63 (41.5)	0.35 (9)
63	1.97 (50)	0.47 (12)	M16x1.5	2.05 (52)	2.64 (67)	0.06 (1.6)	1.26 (32)	0.59 (15)	1.63 (41.5)	0.35 (9)
80	2.36 (60)	0.55 (14)	M20x1.5	2.60 (66)	3.39 (86)	0.10 (2.5)	1.57 (40)	0.59 (15)	1.97 (50)	0.43 (11)
100	2.76 (70)	0.59 (15)	M20x1.5	2.99 (76)	3.78 (96)	0.10 (2.5)	1.57 (40)	0.75 (19)	1.97 (50)	0.43 (11)
125	3.54 (90)	0.79 (20)	M27x2	3.70 (94)	4.88 (124)	0.13 (3.2)	2.13 (54)	0.87 (22)	2.44 (62)	0.55 (14)
160	4.96 (126)	0.98 (25)	M36x2	4.65 (118)	6.14 (156)	0.16 (4)	2.83 (72)	1.22 (31)	3.74 (95)	0.55 (14)
200	5.12 (130)	1.18 (30)	M36x2	4.80 (122)	6.38 (162)	0.16 (4)	2.83 (72)	1.22 (31)	3.74 (95)	0.71 (18)
250	–	–	M42x2	–	–	–	3.31 (84)	–	4.17 (106)	–
320	–	–	M48x2	–	–	–	3.78 (96)	–	4.76 (121)	–

Climax® ISO 6431 Tie Rod Cylinders

Mounting Accessories for Tie Rod Cylinders

Wide Rear Clevis

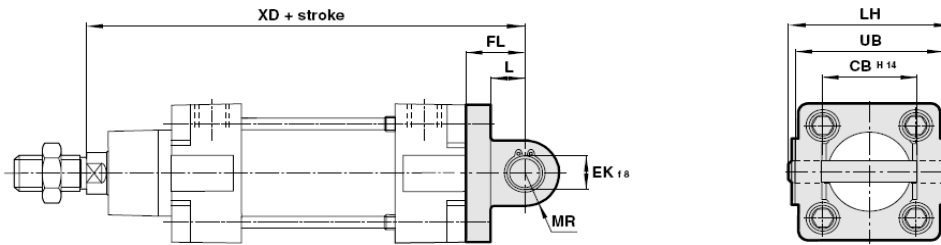

∅ mm	Part Number
32	MP2-032
40	MP2-040
50	MP2-050
63	MP2-063
80	MP2-080
100	MP2-100
125	MP2-125
160	MP2-160
200	MP2-200
250	MP2-250
320	MP2-320

Wide Rear Hinge Bracket

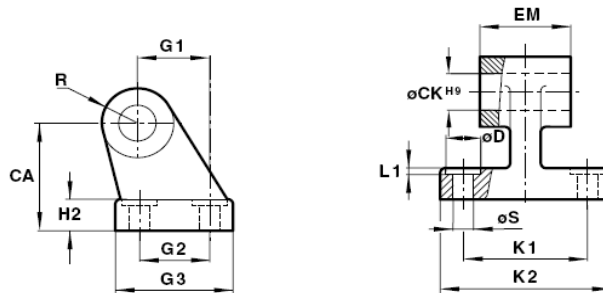

∅ mm	Part Number
32	MC4-032
40	MC4-040
50	MC4-050
63	MC4-063
80	MC4-080
100	MC4-100
125	MC4-125
160	MC4-160
200	MC4-200
250	MC4-250
320	MC4-320

∅mm	CA	CBH14	∅CKH9	∅D	EK18	EM	FL	G1	G2	G3	H2
32	1.26 (32)	1.02 (26)	0.39 (10)	0.43 (11)	0.39 (10)	1.02 (26)	0.87 (22)	0.83 (21)	0.71 (18)	1.22 (31)	0.31 (8)
40	1.42 (36)	1.10 (28)	0.47 (12)	0.43 (11)	0.47 (12)	1.10 (28)	0.98 (25)	0.94 (24)	0.87 (22)	1.38 (35)	0.39 (10)
50	1.77 (45)	1.26 (32)	0.47 (12)	0.59 (15)	0.47 (12)	1.26 (32)	1.06 (27)	1.30 (33)	1.18 (30)	1.77 (45)	0.47 (12)
63	1.97 (50)	1.57 (40)	0.63 (16)	0.59 (15)	0.63 (16)	1.57 (40)	1.26 (32)	1.46 (37)	1.38 (35)	1.97 (50)	0.47 (12)
80	2.48 (63)	1.97 (50)	0.63 (16)	0.71 (18)	0.63 (16)	1.97 (50)	1.42 (36)	1.85 (47)	1.57 (40)	2.36 (60)	0.55 (14)
100	2.80 (71)	2.36 (60)	0.79 (20)	0.71 (18)	0.79 (20)	2.36 (60)	1.61 (41)	2.17 (55)	1.97 (50)	2.76 (70)	0.59 (15)
125	3.54 (90)	2.76 (70)	0.98 (25)	0.79 (20)	0.98 (25)	2.76 (70)	1.97 (50)	2.76 (70)	2.36 (60)	3.54 (90)	0.79 (20)
160	4.53 (115)	3.54 (90)	1.18 (30)	0.79 (20)	1.18 (30)	3.54 (90)	2.17 (55)	3.82 (97)	3.46 (88)	4.96 (126)	0.98 (25)
200	5.31 (135)	3.54 (90)	1.18 (30)	0.94 (24)	1.18 (30)	3.54 (90)	2.36 (60)	4.13 (105)	3.54 (90)	5.12 (130)	1.18 (30)
250	6.50 (165)	4.33 (110)	1.57 (40)	1.30 (33)	1.57 (40)	4.33 (110)	2.76 (70)	5.04 (128)	4.33 (110)	6.30 (160)	1.38 (35)
320	7.87 (200)	4.72 (120)	1.77 (45)	1.57 (40)	1.77 (45)	4.72 (120)	3.15 (80)	5.91 (150)	4.80 (122)	7.32 (186)	1.57 (40)

∅mm	K1	K2	L	L1	LH	MR	R	∅S	UB	XD	
32	1.50 (38)	2.01 (51)	0.51 (13)	0.06 (1.6)	2.05 (52)	0.35 (9)	0.39 (10)	0.26 (6.6)	1.77 (45)	5.59 (142)	
40	1.61 (41)	2.13 (54)	0.63 (16)	0.06 (1.6)	2.36 (60)	0.47 (12)	0.43 (11)	0.26 (6.6)	2.05 (52)	6.30 (160)	
50	1.97 (50)	2.56 (65)	0.67 (17)	0.06 (1.6)	2.68 (68)	0.47 (12)	0.51 (13)	0.35 (9)	2.36 (60)	6.69 (170)	
63	2.05 (52)	2.64 (67)	0.87 (22)	0.06 (1.6)	3.11 (79)	0.59 (15)	0.59 (15)	0.35 (9)	2.76 (70)	7.48 (190)	
80	2.60 (66)	3.39 (86)	0.87 (22)	0.10 (2.5)	3.90 (99)	0.59 (15)	0.59 (15)	0.43 (11)	3.54 (90)	8.27 (210)	
100	3.00 (76)	3.78 (96)	1.06 (27)	0.10 (2.5)	4.69 (119)	0.79 (20)	0.75 (19)	0.43 (11)	4.33 (110)	9.06 (230)	
125	3.70 (94)	4.88 (124)	1.22 (31)	0.13 (3.2)	5.47 (139)	0.98 (25)	0.87 (22)	0.55 (14)	5.12 (130)	10.83 (275)	
160	4.65 (118)	6.14 (156)	1.40 (35.5)	0.16 (4)	7.13 (181)	1.18 (30)	1.22 (31)	0.55 (14)	6.69 (170)	12.40 (315)	
200	4.80 (122)	6.38 (162)	1.41 (36)	0.16 (4)	7.13 (181)	1.18 (30)	1.22 (31)	0.71 (18)	6.69 (170)	13.19 (335)	
250	5.91 (150)	7.87 (200)	1.77 (45)	0.08 (2)	8.60 (218)	1.57 (40)	1.57 (40)	0.87 (22)	7.87 (200)	14.76 (375)	
320	6.69 (170)	9.21 (234)	1.97 (50)	0.08 (2)	9.37 (238)	1.77 (45)	1.77 (45)	1.02 (26)	8.66 (220)	16.54 (420)	

Climax® ISO 6431 Tie Rod Cylinders

Mounting Accessories for Tie Rod Cylinders

Narrow Rear Clevis

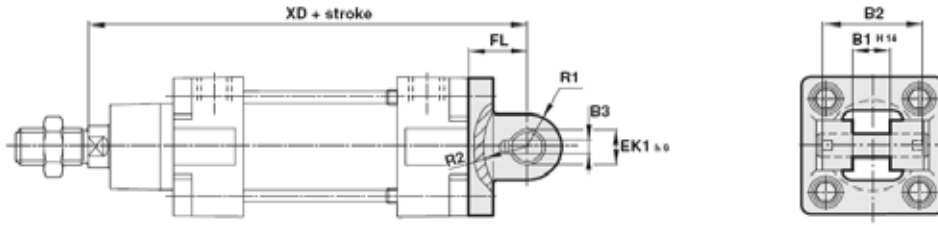

∅ mm	Part Number
32	MP2N-032
40	MP2N-040
50	MP2N-050
63	MP2N-063
80	MP2N-080
100	MP2N-100
125	MP2N-125
160	MP2N-160
200	MP2N-200

Bearing Swivel/Rear Hinge

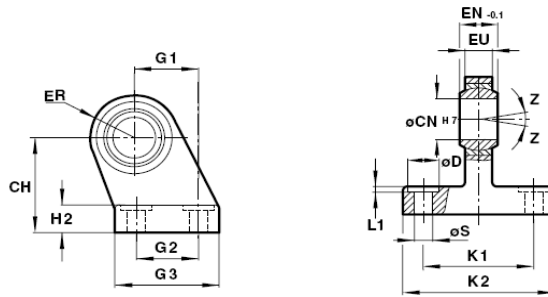

∅ mm	Part Number
32	MFSH-032
40	MFSH-040
50	MFSH-050
63	MFSH-063
80	MFSH-080
100	MFSH-100
125	MFSH-125
160	MFSH-160
200	MFSH-200

∅mm	B1H14	B2	B3	CH	∅CNH7	∅D	∅EKH9	EN-0.1	ER	EU	FL
32	0.55 (14)	1.34 (34)	0.13 (3.3)	1.26 (32)	0.39 (10)	0.43 (11)	0.39 (10)	0.55 (14)	0.63 (16)	0.41 (10.5)	0.87 (22)
40	0.63 (16)	1.57 (40)	0.17 (4.3)	1.42 (36)	0.47 (12)	0.43 (11)	0.47 (12)	0.63 (16)	0.75 (19)	0.47 (12)	0.98 (25)
50	0.83 (21)	1.77 (45)	0.17 (4.3)	1.77 (45)	0.63 (16)	0.59 (15)	0.63 (16)	0.83 (21)	0.83 (21)	0.59 (15)	1.06 (27)
63	0.83 (21)	2.01 (51)	0.17 (4.3)	1.97 (50)	0.63 (16)	0.59 (15)	0.63 (16)	0.83 (21)	0.94 (24)	0.59 (15)	1.26 (32)
80	0.98 (25)	2.56 (65)	0.17 (4.3)	2.48 (63)	0.79 (20)	0.71 (18)	0.79 (20)	0.98 (25)	1.10 (28)	0.71 (18)	1.42 (36)
100	0.98 (25)	2.95 (75)	0.17 (4.3)	2.80 (71)	0.79 (20)	0.71 (18)	0.79 (20)	0.98 (25)	1.18 (30)	0.71 (18)	1.61 (41)
125	1.46 (37)	3.82 (97)	0.25 (6.3)	3.54 (90)	1.18 (30)	0.79 (20)	1.18 (30)	1.46 (37)	1.57 (40)	0.98 (25)	1.97 (50)
160	1.69 (43)	4.80 (122)	0.25 (6.3)	4.53 (115)	1.38 (35)	0.79 (20)	1.38 (35)	1.69 (43)	1.73 (44)	1.10 (28)	2.17 (55)
200	1.69 (43)	4.80 (122)	0.25 (6.3)	5.31 (135)	1.38 (35)	0.94 (24)	1.38 (35)	1.69 (43)	1.89 (48)	1.10 (28)	2.36 (60)

∅mm	G1	G2	G3	H2	K1	K2	L1	R1	R2	∅S	XD
32	0.83 (21)	0.71 (18)	1.22 (31)	0.31 (8)	1.50 (38)	2.01 (51)	0.06 (1.6)	0.43 (11)	0.67 (17)	0.26 (6.6)	5.59 (142)
40	0.94 (24)	0.87 (22)	1.38 (35)	0.39 (10)	1.61 (41)	2.13 (54)	0.06 (1.6)	0.47 (12)	0.79 (20)	0.26 (6.6)	6.30 (160)
50	1.30 (33)	1.18 (30)	1.77 (45)	0.47 (12)	1.97 (50)	2.56 (65)	0.06 (1.6)	0.57 (14.5)	0.87 (22)	0.35 (9)	6.69 (170)
63	1.46 (37)	1.38 (35)	1.97 (50)	0.47 (12)	2.05 (52)	2.64 (67)	0.06 (1.6)	0.71 (18)	0.98 (25)	0.35 (9)	7.48 (190)
80	1.85 (47)	1.57 (40)	2.36 (60)	0.55 (14)	2.60 (66)	3.39 (86)	0.10 (2.5)	0.87 (22)	1.18 (30)	0.43 (11)	8.27 (210)
100	2.17 (55)	1.97 (50)	2.76 (70)	0.59 (15)	2.99 (76)	3.78 (96)	0.10 (2.5)	0.87 (22)	1.26 (32)	0.43 (11)	9.06 (230)
125	2.76 (70)	2.36 (60)	3.54 (90)	0.79 (20)	3.70 (94)	4.88 (124)	0.13 (3.2)	1.18 (30)	1.65 (42)	0.55 (14)	10.83 (275)
160	3.82 (97)	3.46 (88)	4.96 (126)	0.98 (25)	4.65 (118)	6.14 (156)	0.16 (4)	1.42 (36)	1.81 (46)	0.55 (14)	12.40 (315)
200	4.13 (105)	3.54 (90)	5.12 (130)	1.18 (30)	4.80 (122)	6.38 (162)	0.16 (4)	1.50 (38)	1.93 (49)	0.71 (18)	13.19 (335)

Climax® ISO 6431 Tie Rod Cylinders

Mounting Accessories for Tie Rod Cylinders

Rear Eye

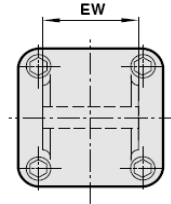
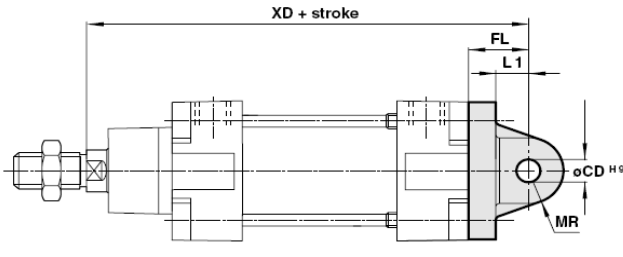

ø mm	Part Number
32	MP4-032
40	MP4-040
50	MP4-050
63	MP4-063
80	MP4-080
100	MP4-100
125	MP4-125
160	MP4-160
200	MP4-200

Swivel Rear Eye

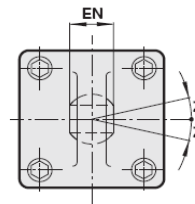
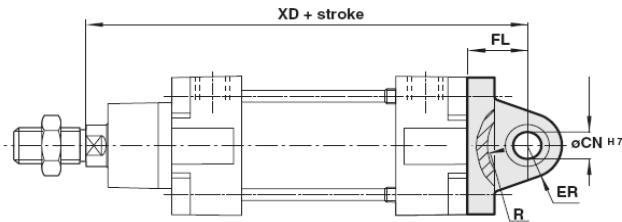

ø mm	Part Number
32	MP4S-032
40	MP4S-040
50	MP4S-050
63	MP4S-063
80	MP4S-080
100	MP4S-100
125	MP4S-125
160	MP4S-160
200	MP4S-200

ømm	øCDH9	øCNH7	EN	ER	EW	FL	L1	MR	R	XD	Z
32	0.39 (10)	0.39 (10)	0.55 (14)	0.63 (16)	1.02 (25.8)	0.87 (22)	0.51 (13)	0.35 (9)	0.57 (14.5)	5.59 (142)	13°
40	0.47 (12)	0.47 (12)	0.63 (16)	0.75 (19)	1.09 (27.8)	0.98 (25)	0.63 (16)	0.47 (12)	0.71 (18)	6.30 (160)	13°
50	0.47 (12)	0.63 (16)	0.83 (21)	0.83 (21)	1.25 (31.7)	1.06 (27)	0.67 (17)	0.47 (12)	0.75 (19)	6.69 (170)	13°
63	0.63 (16)	0.63 (16)	0.83 (21)	0.94 (24)	1.56 (39.7)	1.26 (32)	0.87 (22)	0.59 (15)	0.94 (24)	7.48 (190)	15°
80	0.63 (16)	0.79 (20)	0.98 (25)	1.10 (28)	1.96 (49.7)	1.42 (36)	0.87 (22)	0.59 (15)	0.94 (24)	8.27 (210)	15°
100	0.79 (20)	0.79 (20)	0.98 (25)	1.18 (30)	2.35 (59.7)	1.61 (41)	1.06 (27)	0.79 (20)	1.14 (29)	9.06 (230)	15°
125	0.98 (25)	1.18 (30)	1.46 (37)	1.57 (40)	2.74 (69.7)	1.97 (50)	1.30 (33)	0.98 (25)	1.42 (36)	10.83 (275)	15°
160	1.18 (30)	1.38 (35)	1.69 (43)	1.73 (44)	3.53 (89.7)	2.17 (55)	1.40 (35.5)	1.18 (30)	1.61 (41)	12.40 (315)	16°
200	1.18 (30)	1.38 (35)	1.69 (43)	1.89 (48)	3.53 (89.7)	2.36 (60)	1.46 (37)	1.18 (30)	1.65 (42)	13.19 (335)	16°

Climax® ISO 6431 Tie Rod Cylinders

Mounting Accessories for Tie Rod Cylinders

Central Trunnion

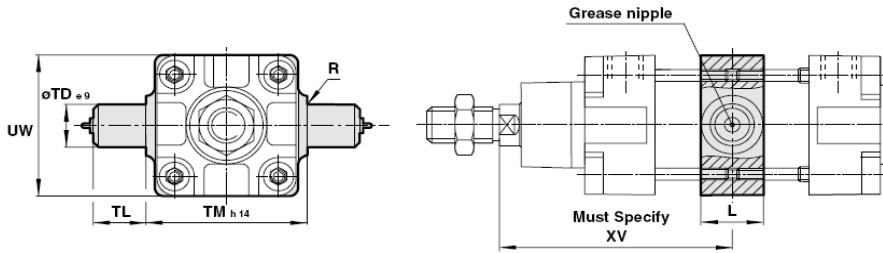

ϕ mm	Part Number
32	MT4-032
40	MT4-040
50	MT4-050
63	MT4-063
80	MT4-080
100	MT4-100
125	MT4-125
160	MT4-160
200	MT4-200
250	MT4-250
320	MT4-320

Adjustable Trunnion

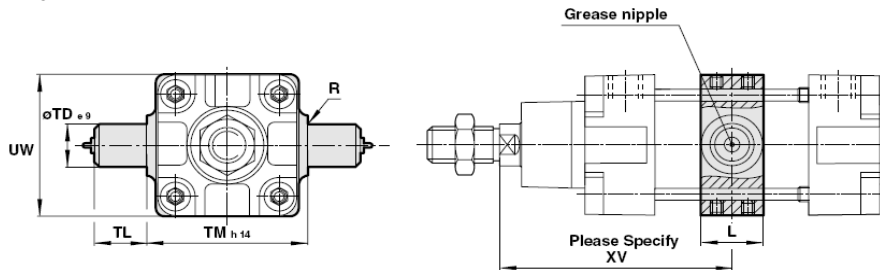

ϕ mm	Part Number
32	MT4A-032
40	MT4A-040
50	MT4A-050
63	MT4A-063
80	MT4A-080
100	MT4A-100
125	MT4A-125
160	MT4A-160
200	MT4A-200
250	MT4A-250
320	MT4A-320

ϕ mm	L	R	ϕTD_{e9}	TL	TM _{h14}	UW	XV min	XV max	Torque
32	0.79 (20)	0.04 (1)	0.47 (12)	0.47 (12)	1.97 (50)	1.97 (50)	2.50 (63.5)	3.25 (82.5)	4.4 (6)
40	0.94 (24)	0.06 (1.6)	0.63 (16)	0.63 (16)	2.48 (63)	2.28 (58)	2.91 (74)	3.58 (91)	4.4 (6)
50	1.10 (28)	0.06 (1.6)	0.63 (16)	0.63 (16)	2.95 (75)	2.76 (70)	3.23 (82)	3.86 (98)	7.4 (10)
63	1.10 (28)	0.06 (1.6)	0.79 (20)	0.79 (20)	3.54 (90)	3.15 (80)	3.31 (84)	4.37 (111)	7.4 (10)
80	1.10 (28)	0.06 (1.6)	0.79 (20)	0.79 (20)	4.33 (110)	3.94 (100)	3.66 (93)	5.00 (127)	11.1 (15)
100	1.50 (38)	0.08 (2)	0.98 (25)	0.98 (25)	5.20 (132)	4.96 (126)	4.21 (107)	5.24 (133)	11.1 (15)
125	1.97 (50)	0.08 (2)	0.98 (25)	0.98 (25)	6.30 (160)	5.98 (152)	5.35 (136)	6.06 (154)	18.4 (25)
160	1.97 (50)	0.10 (2.5)	1.26 (32)	1.26 (32)	7.87 (200)	7.56 (192)	6.10 (155)	7.28 (185)	29.5 (40)
200	1.97 (50)	0.10 (2.5)	1.26 (32)	1.26 (32)	9.84 (250)	9.45 (240)	6.69 (170)	7.87 (200)	29.5 (40)
250	2.36 (60)	0.13 (3.2)	1.57 (40)	1.57 (40)	12.60 (320)	12.52 (318)	7.60 (193)	8.54 (217)	–
320	2.76 (70)	0.13 (3.2)	1.97 (50)	1.97 (50)	15.75 (400)	15.75 (400)	8.46 (215)	9.65 (245)	–

Climax® ISO 6431 Tie Rod Cylinders

Mounting Accessories for Tie Rod Cylinders

Head Detachable Trunnion

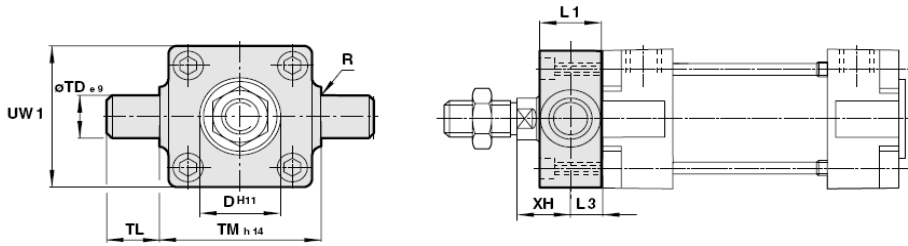

ø mm	Part Number
32	MT6-032
40	MT6-040
50	MT6-050
63	MT6-063
80	MT6-080
100	MT6-100
125	MT6-125

Cap Detachable Trunnion

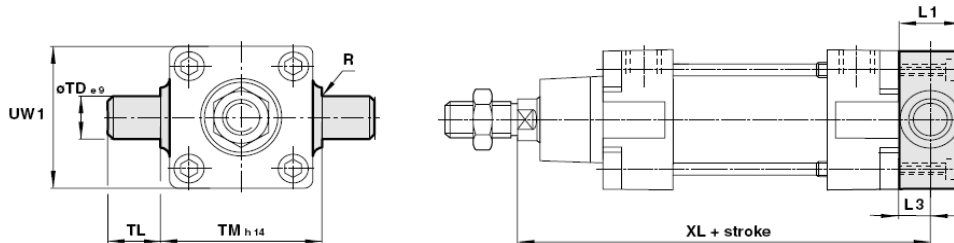

ø mm	Part Number
32	MT6-032
40	MT6-040
50	MT6-050
63	MT6-063
80	MT6-080
100	MT6-100
125	MT6-125

Swivel Bearing for Trunnion Mounts

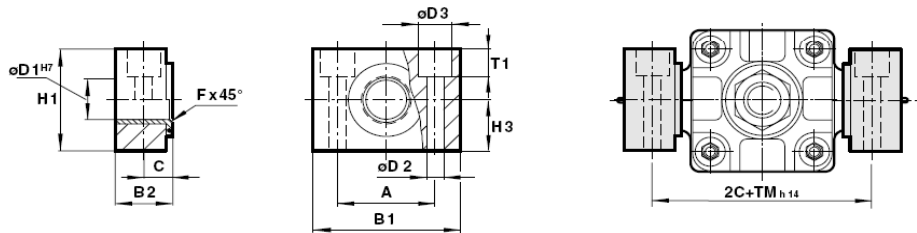

ø mm	Part Number
32	MT2-032
40	MT2-040/050
50	MT2-040/050
63	MT2-063/080
80	MT2-063/080
100	MT2-100/125
125	MT2-100/125
160	MT2-160/200
200	MT2-100/125

ømm	A	B1	B2	C	øDH11	øD1H7	øD2	øD3	Fx45°	H1	H3
32	1.26 (32)	1.81 (46)	0.71 (18)	0.41 (10.5)	1.18 (30)	0.47 (12)	0.26 (6.6)	0.43 (11)	0.04 (1)	1.18 (30)	0.59 (15)
40	1.42 (36)	2.17 (55)	0.83 (21)	0.47 (12)	1.38 (35)	0.63 (16)	0.35 (9)	0.59 (15)	0.06 (1.6)	1.42 (36)	0.71 (18)
50	1.42 (36)	2.17 (55)	0.83 (21)	0.47 (12)	1.57 (40)	0.63 (16)	0.35 (9)	0.59 (15)	0.06 (1.6)	1.42 (36)	0.71 (18)
63	1.65 (42)	2.56 (65)	0.91 (23)	0.51 (13)	1.77 (45)	0.79 (20)	0.43 (11)	0.71 (18)	0.06 (1.6)	1.57 (40)	0.79 (20)
80	1.65 (42)	2.56 (65)	0.91 (23)	0.51 (13)	1.77 (45)	0.79 (20)	0.43 (11)	0.71 (18)	0.06 (1.6)	1.57 (40)	0.79 (20)
100	1.97 (50)	2.95 (75)	1.12 (28.5)	0.63 (16)	2.17 (55)	0.98 (25)	0.55 (14)	0.79 (20)	0.08 (2)	1.97 (50)	0.98 (25)
125	1.97 (50)	2.95 (75)	1.12 (28.5)	0.63 (16)	2.36 (60)	0.98 (25)	0.55 (14)	0.79 (20)	0.08 (2)	1.97 (50)	0.98 (25)
160	2.36 (60)	3.62 (92)	1.54 (39)	0.85 (21.5)	-	1.26 (32)	0.71 (18)	1.02 (26)	0.10 (2.5)	2.36 (60)	1.18 (30)
200	2.36 (60)	3.62 (92)	1.54 (39)	0.85 (21.5)	-	1.26 (32)	0.71 (18)	1.02 (26)	0.10 (2.5)	2.36 (60)	1.18 (30)

ømm	L1	L3	R	øTDe9	TL	TMh14	T1	UW1	XH	XL
32	0.63 (16)	0.31 (8)	0.04 (1)	0.47 (12)	0.47 (12)	1.97 (50)	0.31 (6.8)	1.97 (50)	0.71 (18)	5.04 (128)
40	0.79 (20)	0.39 (10)	0.06 (1.6)	0.63 (16)	0.63 (16)	2.48 (63)	0.35 (9)	2.17 (55)	0.79 (20)	5.71 (145)
50	0.94 (24)	0.47 (12)	0.06 (1.6)	0.63 (16)	0.63 (16)	2.95 (75)	0.35 (9)	2.56 (65)	0.98 (25)	6.10 (155)
63	0.94 (24)	0.47 (12)	0.06 (1.6)	0.79 (20)	0.79 (20)	3.54 (90)	0.43 (11)	2.95 (75)	0.98 (25)	6.69 (170)
80	1.10 (28)	0.55 (14)	0.06 (1.6)	0.79 (20)	0.79 (20)	4.33 (110)	0.43 (11)	3.94 (100)	1.26 (32)	7.40 (188)
100	1.50 (38)	0.75 (19)	0.08 (2)	0.98 (25)	0.98 (25)	5.20 (132)	0.51 (13)	4.72 (120)	1.26 (32)	8.19 (208)
125	1.97 (50)	0.98 (25)	0.08 (2)	0.98 (25)	0.98 (25)	6.30 (160)	0.51 (13)	5.71 (145)	1.57 (40)	9.84 (250)
160	-	-	0.10 (2.5)	1.26 (32)	1.26 (32)	7.87 (200)	0.61 (15.5)	-	-	-
200	-	-	0.10 (2.5)	1.26 (32)	1.26 (32)	9.84 (250)	0.61 (15.5)	-	-	-

Climax® ISO 6431 Tie Rod Cylinders

Mounting Accessories for Tie Rod Cylinders

Piston Rod/Swivel Mount

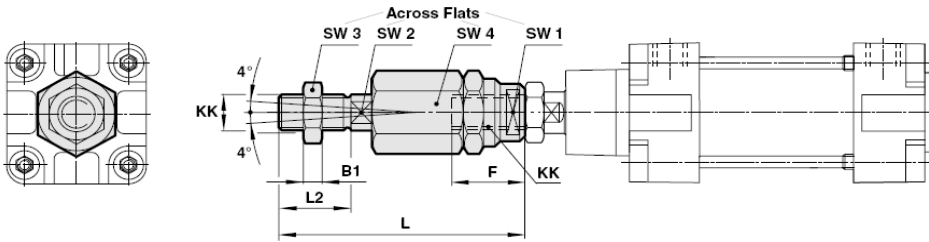

ø mm	Part Number
32	FES10x125
40	FES12x125
50	FES16x150
63	FES16x150
80	FES20x150
100	FES20x150
125	FES27x200
160	FES36x200
200	FES36x200

Spherical Rod End

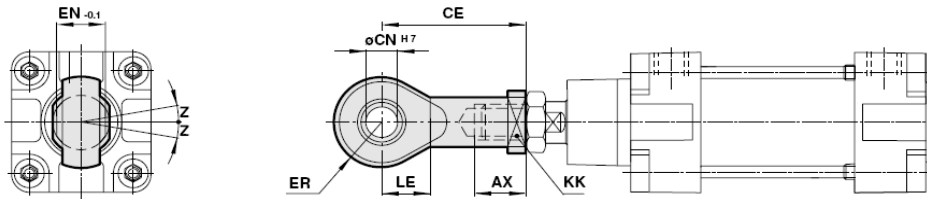

ø mm	Part Number
32	FER10x125
40	FER12x125
50	FER16x150
63	FER16x150
80	FER20x150
100	FER20x150
125	FER27x200
160	FER36x200
200	FER36x200
250	FER42x200
320	FER48x200

ømm	AX	B1	CE	øCNH7	EN-01	ER	F	KK
32	0.79 (20)	0.20 (5)	1.69 (43)	0.39 (10)	0.55 (14)	0.55 (14)	1.02 (26)	M10x1.25
40	0.87 (22)	0.24 (6)	1.97 (50)	0.47 (12)	0.63 (16)	0.63 (16)	1.02 (26)	M12x1.25
50	1.10 (28)	0.31 (8)	2.52 (64)	0.63 (16)	0.83 (21)	0.83 (21)	1.34 (34)	M16x1.5
63	1.10 (28)	0.31 (8)	2.52 (64)	0.63 (16)	0.83 (21)	0.83 (21)	1.34 (34)	M16x1.5
80	1.30 (33)	0.39 (10)	3.03 (77)	0.79 (20)	0.98 (25)	0.98 (25)	1.65 (42)	M20x1.5
100	1.30 (33)	0.39 (10)	3.03 (77)	0.79 (20)	0.98 (25)	0.98 (25)	1.65 (42)	M20x1.5
125	2.01 (51)	0.53 (13.5)	4.33 (110)	1.18 (30)	1.46 (37)	1.38 (35)	1.57 (40)	M27x2
160	2.20 (56)	0.71 (18)	4.92 (125)	1.38 (35)	1.69 (43)	1.57 (40)	3.07 (78)	M36x2
200	2.20 (56)	0.71 (18)	4.92 (125)	1.38 (35)	1.69 (43)	1.57 (40)	3.07 (78)	M36x2
250	2.36 (60)	–	5.59 (142)	1.57 (40)	1.93 (49)	1.77 (45)	–	M42x2
320	2.56 (65)	–	6.30 (160)	1.97 (50)	2.36 (60)	2.28 (58)	–	M48x2

ømm	L	L2	LE	SW1	SW2	SW3	SW4	Z
32	2.87 (73)	0.79 (20)	0.59 (15)	0.75 (19)	0.47 (12)	0.67 (17)	1.18 (30)	13°
40	3.03 (77)	0.94 (24)	0.67 (17)	0.75 (19)	0.47 (12)	0.75 (19)	1.18 (30)	13°
50	4.17 (106)	1.26 (32)	0.87 (22)	1.18 (30)	0.75 (19)	0.94 (24)	1.65 (42)	15°
63	4.17 (106)	1.26 (32)	0.87 (22)	1.18 (30)	0.75 (19)	0.94 (24)	1.65 (42)	15°
80	4.80 (122)	1.57 (40)	1.02 (26)	1.18 (30)	0.75 (19)	1.18 (30)	1.65 (42)	15°
100	4.80 (122)	1.57 (40)	1.02 (26)	1.18 (30)	0.75 (19)	1.18 (30)	1.65 (42)	15°
125	5.79 (147)	2.13 (54)	1.42 (36)	1.57 (40)	0.94 (24)	1.61 (41)	2.17 (55)	15°
160	9.88 (251)	2.83 (72)	1.61 (41)	1.97 (50)	1.42 (36)	2.17 (55)	2.95 (75)	16°
200	9.88 (251)	2.83 (72)	1.61 (41)	1.97 (50)	1.42 (36)	2.17 (55)	2.95 (75)	16°
250	–	–	1.81 (46)	–	–	–	–	17°
320	–	–	2.32 (59)	–	–	–	–	12°

Climax® ISO 6431 Tie Rod Cylinders

Position Sensing for Tie Rod Cylinders

UL-21 Series

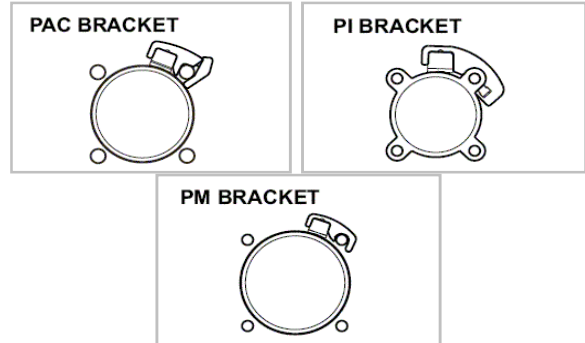

Specifications

CHARACTERISTIC/TYPE	UL-21R	UL-21N	UL-21P
Switching Logic	SPST Normally Open	Solid State Output, Normally Open	
Sensor Type	Reed Switch	NPN Current Sinking	PNP Current Sourcing
Operating Voltage (Note 1)	5 ~ 240V DC/AC	5 ~ 28V DC	
Switching Current	100 mA max.	200 mA max.	
Switching Rating	10 W max.	6 W max.	
Current Consumption		15 mA max. @ 24V (Switch Active)	16 mA max. @ 24V (Switch Active)
Voltage Drop	2.5 V max. @ 40mA DC	1.5 V max. @ 200 mA (Resistive Load)	
Leakage Current		0.01 mA max.	
Indicator	Red LED	Red LED	Green LED
Cable	4.0 §, 2C, OIL RESISTANT PVC	4.0 §, 3C, OIL RESISTANT PVC	
Sensitivity (Note 2)	70 Gauss	60 Gauss	
Max. Switching Frequency	200 Hz	1000 Hz	
Temperature Range		-10 ~ 70	
Shock (Note 3)	30 G	50 G	
Vibration (Note 4)		9G	
Enclosure Classification		IP 67 (NEMA 6)	
Protection Circuit		Power Source Reverse Polarity; Surge Suppression; O/P Short Circuit Protect	

Wiring Diagram

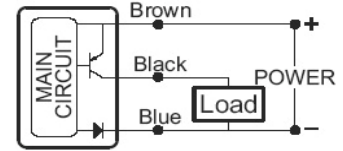
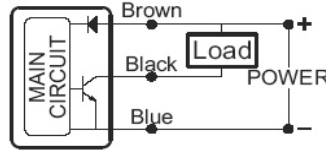
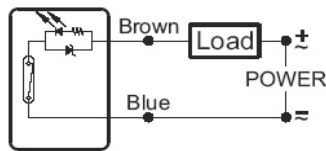

UL-21R-03
UL-21R-QC8

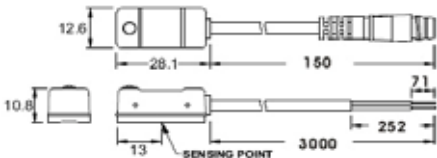

UL-21N(P)-03
UL-21N(P)-QC8

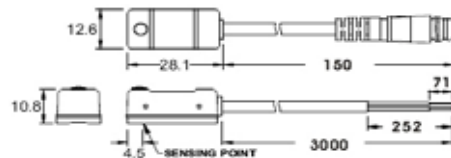

M8 Quick Connector (IEC61076-2-101)

2 wire QC wiring



3 wire QC wiring





- NOTE: 1. The max. Operating voltage of UL-21R-QC8 is 60V AC/DC (based on IEC61076-2-101).
 2. Measuring standard target: 15.5 * 8 * 5t (Anisotropic Rubber Magnet).
 3. Sin Wave /X -Y- -Z 3 Directions / 3 Times Each Direction/ 11mS Each Time
 4. Double Amplitude 1.5mm / 10Hz ~55Hz~10Hz (Sweep 1 min) /X -Y- -Z





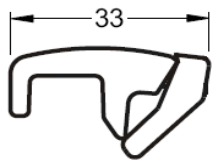
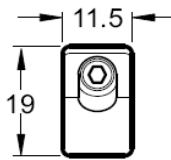

Climax® ISO 6431 Tie Rod Cylinders

Mounting Brackets for Tie Rod Cylinders

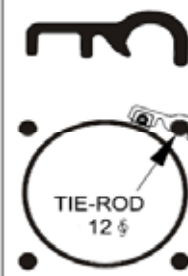

PAC BRACKET

	PAC	MATERIAL: ZINC DIE-CAST			
	APPLY TO 32 ϕ TO 125 ϕ TIE-ROD CYLINDER (BORE SIZE FROM 5 ϕ TO 12 ϕ)				

PM BRACKET

	PM - 6	PM - 8	PM - 10	PM - 12	PM - 16
					

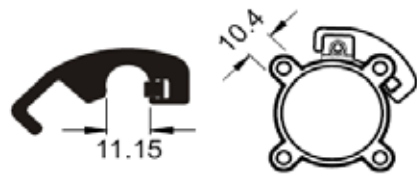
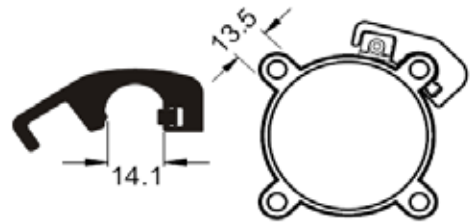
PI BRACKET

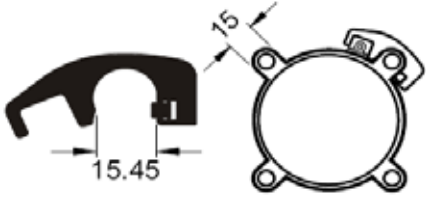
	PI-1		PI-2	
	Apply to 32 ϕ to 40 ϕ ISO Profile Cylinder		Apply to 50 ϕ to 63 ϕ ISO Profile Cylinder	
	PI-3		PI-4	